



20 twenty years of advanced solutions for gas detection

Gas Sensing Elements Proudly 100% Developed and Manufactured in Italy

# IREF 32mm R417a

## Market's most DEPENDABLE refrigerant gas sensor

DS4219 rev.2 dated 25/05/2018

### Key Features



- SIL2 rated, for certified dependability (fail-safe detection)
- Standard industrial 7-series size, to fit existing detectors
- 1-year calibration span, to reduce maintenance costs
- MTBF of more than 5 years, for greater sensor lifetime
- The most comprehensive range of targeted gases on the market
- Extended temperature range (-20 to +50 °C), for use in any environment
- Fast T90 response time and superior selectivity, for critical and life-saving applications
- ModBus or analogue output, for ease of integration
- Internal microprocessor, for advanced signal processing
- Solid, rugged construction with stainless steel enclosure

### General Description

N.E.T. IREF is market's most DEPENDABLE refrigerant gas sensor. Design your own fail-safe leak detection systems with state-of-the-art NDIR (Non Dispersive InfraRed) technology. Lower your total cost of ownership and stand out from your competition with better accuracy, selectivity and reliability.

N.E.T. IREF sensors have the market's most comprehensive range of targeted gases, allowing detection in ppm and LEL range of HFCs, HFOs and SF6. You can easily expand your range, as all sensors have the same built and interface.

N.E.T. IREF implements N.E.T. advanced NDIR, black body and microprocessor technology to eclipse classic semiconductor (MOS) sensor performances, reducing maintenance costs (guaranteed 1-year calibration span), increasing sensor lifetime and making your leak detection fail-safe, while offering the best gas selectivity available and a fast response time.

N.E.T. sensors are EN 50271 & SIL2 (TUV) approved and they are designed to fit into fixed gas monitors compliant with all the relevant refrigerant standards, along with portable electronic leak detectors.

All N.E.T. IR sensors run on a microprocessor-based platform for internal signal processing, providing a linearized and temperature compensated output in digital and analogue format – the ideal solution for instrument manufacturers, even without any specialist knowledge in IR technology.

N.E.T. IR sensor series apply NDIR (Non Dispersive Infra-red) detection technique. This technique is based on the

fact each gas has an unique and well defined light absorption curve in the infrared spectrum that can be used to identify the specific gas. The concentration can be determined by using a suitable infrared source and analysing the quantity of energy absorbed from the gas inside the optical path.

Infrared gas sensors employ a dual wavelength technique, using an IR energy source aimed at two pyroelectric detectors, each sensitive to different ranges of wavelengths in the spectrum's infrared portion. The differential absorption technique, where the target gas is always monitored with respect to a reference measurement, attenuates the effect of background distortions due to response to other gases, source aging or optical surface contamination.

The analogue output can be set as: standard voltage type [0.4 V–2 V] dc (other voltages are available on request) (fig. 1).

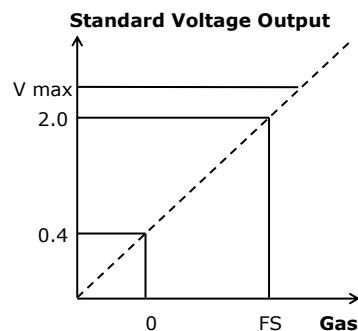
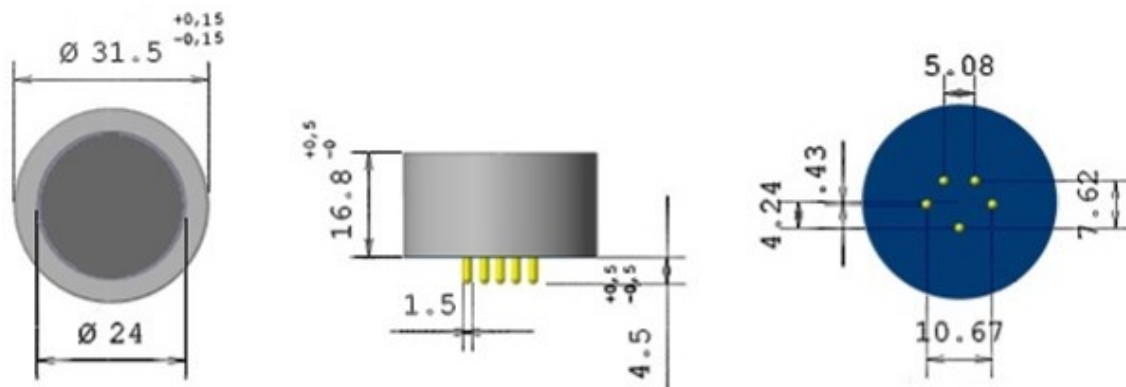
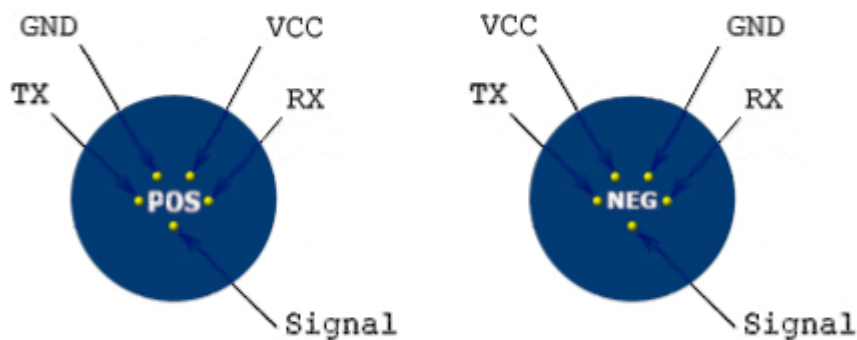

Fig. 1: Characteristics of output voltage

## Mechanical specifications



## Pinout



## Certification details

SIL Certification	<b>SIL certification number</b>	PS-23125-22-L-01
	<b>Reference standards</b>	EN 50402:2017 ; EN 61508:2010 parts 1 to 7
	<b>Systematic and random integrity</b>	SIL3 capable, SIL2 or SIL3 depending on configuration
	<b>Performance approval</b>	Designed for use in a detector that complies to IEC EN 60079-29-1

## Digital Communication

Digital Interface	<b>Digital signal format</b>	8 data bits, 1 stop bit, no parity
	<b>Standard Baud rate</b>	4800 bps ad Default; 9600,19200,38400 bps
	<b>TX- VOH: output "High" minimum voltage</b>	2.4V
	<b>TX- VOL: output "Low" maximum voltage</b>	0.4V
	<b>RX- VIH: input "High" minimum voltage</b>	2V
	<b>RX- VIL: input "Low" maximum voltage</b>	0.8V

## Linearity

The linearity at room temperature, is:  $\pm 1\%$  of FS range for readings below 25% of range;  $\pm 2\%$  of FS range for readings below 50% of range and  $\pm 5\%$  of FS range above 50% of range. The following graphs show the linearity data for 15 sensors.

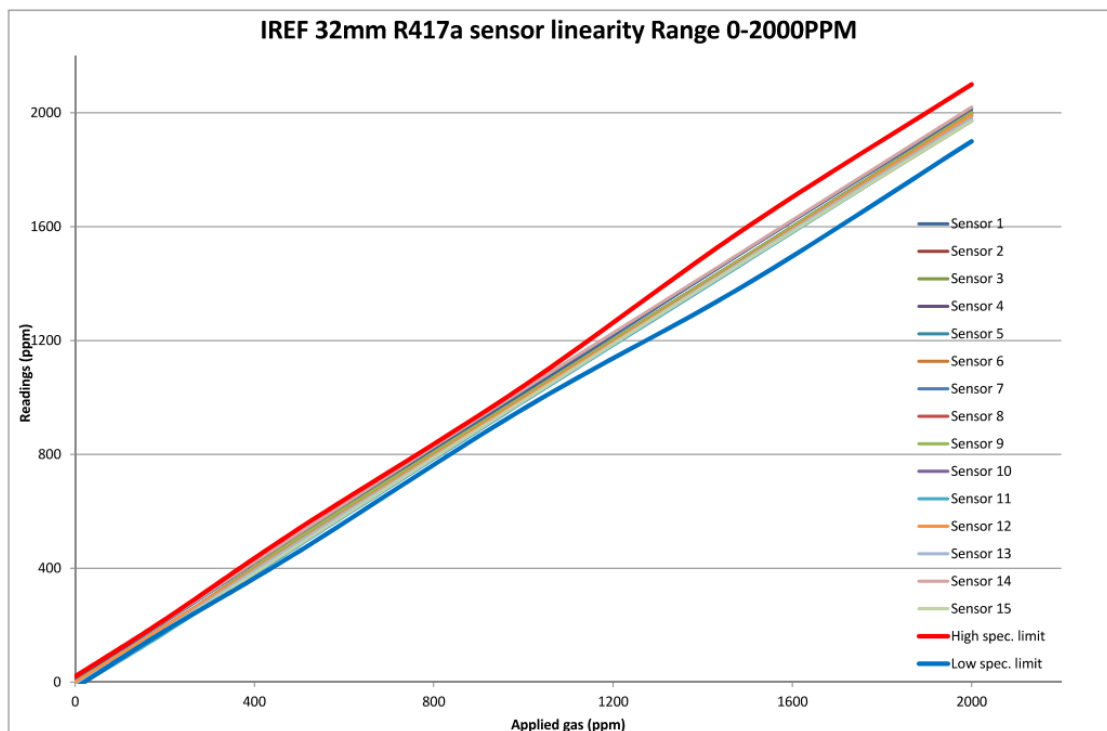

## Temperature compensation

Sensors are tested individually in climatic chambers at temperature extremes ( $-20^{\circ}\text{C}$  and  $+50^{\circ}\text{C}$ ) to adjust the internal thermistor compensation. Performances in the temperature range are:  $\pm 3\%$  of FS range for readings below 50% of the range and  $\pm 5\%$  of FS range above 50% of the range.

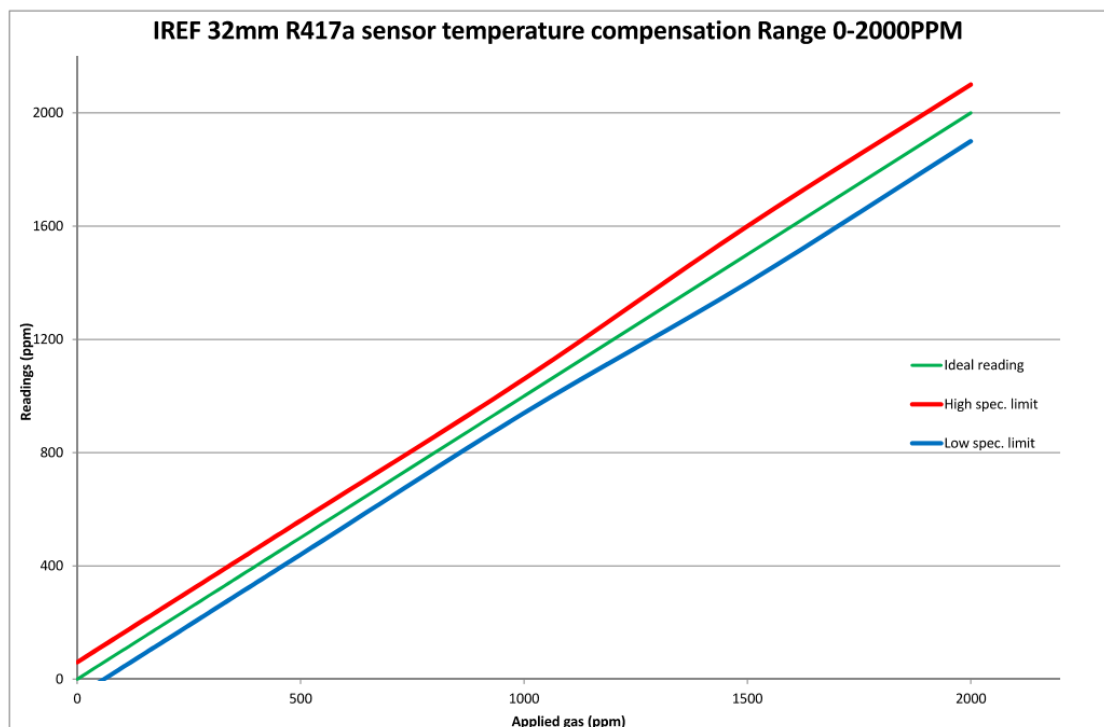

## Product specifications

General	<b>Operating temperature range</b>	-20 to +50 °C
	<b>Storage temperature range</b>	-40 to +85 °C
	<b>Maximum temperature cycle variations</b>	± 1°C/min
	<b>Operating humidity range</b>	0-95% non condensing
	<b>Operating pressure range</b>	800-1200 mBar
	<b>Gas types</b>	R417a
	<b>Weight</b>	34 g
	<b>MTBF</b>	≥ 5 years
	<b>Patent information</b>	MI2013A000478, EP14001065, US14/219631, CA2.847.491
	<b>Firmware and digital technology</b>	Designed for use in a detector that complies to EN 50271 <b>SIL2 (TÜV approved)</b>
	<b>Electromagnetic Compatibility (EMC)</b>	Designed for use in a detector that complies to EN 50270
	<b>Optics</b>	Metal optics treated to increase brightness and prevent oxidation
	<b>Enclosure</b>	Stainless steel
<b>Calibration</b>	Individually calibrated with temperature compensation. Test report supplied.	
Measurement	<b>Sensing method</b>	NDIR (dual beam technology)
	<b>Measurement range</b>	0 - 2000 ppm
	<b>Repeatability</b>	±1% of FS range
	<b>Accuracy *</b>	±1% of FS range for readings below 25% of range ±2% of FS range for readings below 50% of range ±5% of FS range above 50% of range
	<b>Resolution</b>	0.2% of F.S range
	<b>Long Term Zero Stability</b>	±2% of FS range/year
	<b>Temperature Performance</b>	±3% of FS range for readings below 50% of range ±5% of FS range above 50% of range
	<b>Pressure dependence</b>	0.1 % to 0.2 % value per hPa
	<b>Zero level Humidity Error</b>	±0.5% of FS range
	<b>Response time</b>	T <sub>50</sub> ≤ 15 s; T <sub>90</sub> ≤ 30 s
Electrical	<b>Power voltage</b>	4.5 - 5.5 Vdc
	<b>Operating current</b>	110 mA Idc average (@ 4.5Vdc) 85 mA Idc average (@ 5Vdc)
	<b>Warm up time</b>	60 s for full operation @ 25 °C At least 1 hour for full specification @ 25 °C
	<b>Max output current</b>	±7.5 mA
	<b>DC output impedance</b>	100 Ω
	<b>Max capacitance load</b>	1000 pF
Signal Output	<b>Analog output (standard for voltage mode)</b>	Standard voltage [0.4 V—2 V] dc (other voltages available on request)
	<b>Digital communication</b>	MODBUS protocol communication (documentation available on request) Compatible UART P2P protocol

\* Test conditions: 25°C ambient temperature and 1000hPa absolute pressure

## Ordering details

When making an order, we kindly ask our customers to specify the basic physical and electrical properties that are needed for their specific application. This is made through the part number here below. The squared fields of the part number below can be modified according to the options on the right. See DS2203 for complete instructions on how to compile the part number for the entire IR series.

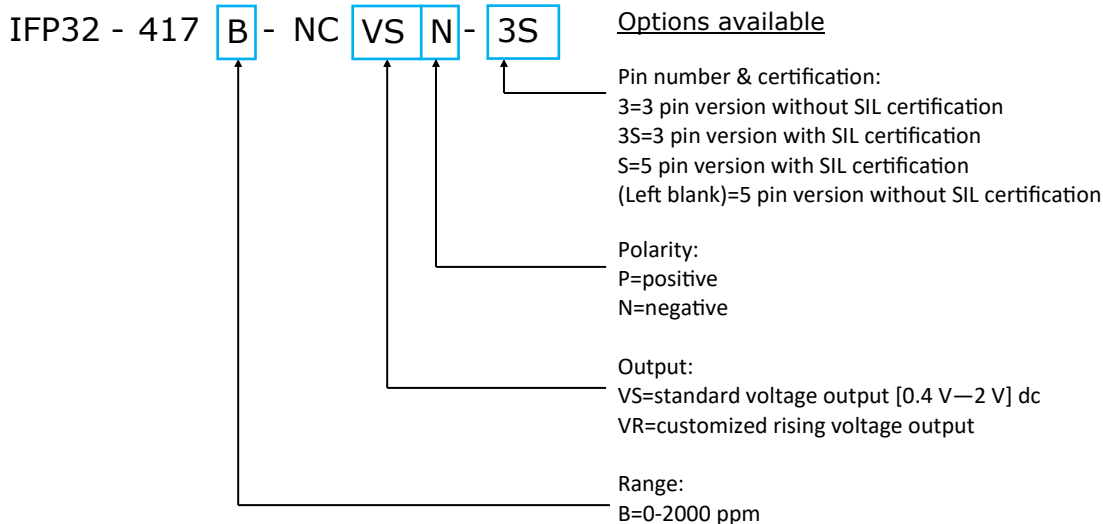

## Warranty and warning

The WARRANTY of IREF-P 32mm sensors is 1 years from the purchased date against defects in materials or production. This warranty however is not valid for articles that have been broken, repaired by a third person or not used according to the instructions contained in this document or supplied with the products, related to the storage, installation, operation, maintenance, or servicing of the products.

Please keep particular attention to:

- Power the sensor observing the correct voltage and polarity (positive or negative)
- Never solder directly on the pin, use PCB sockets
- Never cut or remove any of the pins
- Use anti-static precautions when handling the sensor
- Never let water or other liquids to enter inside the sensor
- Never expose the sensor to corrosive gases
- The gas flow used for testing should be  $\leq 500$  SCCM
- Recalibration of the sensor will void the calibration warranty

**N.E.T. has a policy of continuous development and improvement of its products. As such the specification for the device outlined in the data sheet may be changed without notice. In case of modification of the product, N.E.T. disclaims all liability.**

**No part of this publication may be reproduced, distributed, or transmitted in any form or by any means, including photocopying, recording, or other electronic or mechanical methods, without the prior written permission of N.E.T. For permission requests or technical support please contact or write to the address below:**



N.E.T. SRL  
Via Campania, 5 | 20006 | Pregnana Milanese | Milano | Italy  
T +39.02.9354.4190  
E info@nenvitech.com  
www.nenvitech.com